

## How Software AG built up its Online Communities with OpenCms

*Robert Diawara, Software AG*

*Fabian Huschka, componio GmbH*

# Module 1

## Software AG & componio GmbH at a glance

## Software AG at a glance

- Revenue over €1 billion
- Global Leader for Process & Integration Solutions
- 10,000 of enterprise & public customers
- Over 5,600 employees worldwide
  - 3,500 services consultants
  - 850 R&D staff
- Offices in 70+ countries
- Software AG Foundation

HSBC 

*Coca-Cola Enterprises Inc.*



CABLE & WIRELESS

SONY®

ExxonMobil



COX



vodafone

TELUS®

citibank®

Deutsche Post 



Bank of America



*Johnson & Johnson*

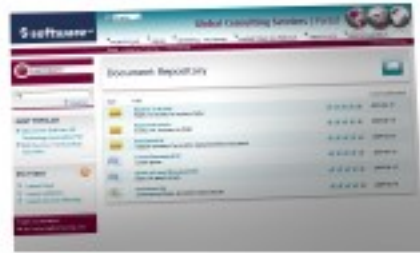

## componio GmbH

- $\text{Math.ceil}(5600 \cdot 10^{-3}) + 1 = 7$  Employees
- Located in Darmstadt, Germany
- Web-Centric Software Development
  - Knowledge Management
  - Social Media
  - Information Portals
- OpenCms development since 2005



componio  
components & intelligent objects

# Module 2

## Software AG Communities

## Why Communities ?

### Software AG

- Impacting prospect decision-making
- Reduced support cost
- Customer retention
  - Skills argument
  - Innovation
- Improve perception
- Extended marketing channel
- Meet customer demand

### Customer

- Benefit from best practices
- Collaborate with peers
- All-In-One information portal
- Stay up to date on latest product releases
- Skills building
- Developer productivity
  - Knowledge base
  - Code samples

# Community Websites - <http://communities.softwareag.com>

- Promotions
  - product news
  - Webinars
  - Events
- Latest forum posts viewable inside web page
- Key Resources
  - Wiki Articles
  - Code Samples
  - Videos
  - Documentation
  - Free Downloads
  - TECHniques Customer newsletter



The screenshot displays the software AG Communities website interface. At the top, there is a navigation bar with the software AG logo and the word "Communities". Below this, there are several community pages stacked on top of each other, each representing a different product line:

- Adabas Community** (Thursday, September 30, 2010): Features "ADABAS PRODUCTS" including Roadmap (September 2010), Adabas, Adabas on Mainframes, and Adabas on Open Systems.
- Natural Community** (Tuesday, October 5, 2010): Features "NATURAL PRODUCTS" including Roadmap (May 19, 2010), NaturalONE, Natural General, and Natural for Mainframes.
- CentraSite Community** (Tuesday, October 5, 2010): Features "CENTRASITE PRODUCTS" including Active SOA, Community Edition, Enterprise Edition, Governance Edition, and Mediator.
- webMethods Community** (Tuesday, October 5, 2010): Features "WEBMETHODS PRODUCTS" including Adapters, Applinx and EntireX, BPM Suite, Business Activity Monitoring, Composite Application Framework, ESB B. Integration, Suite, and Tamino.
- ARIS Community** (Friday, March 25, 2011): Features "ARIS PRODUCTS" including ARIS Express, ARIS Strategy, ARIS Design, ARIS Implementation, ARIS Controlling, ARISalign, /MeshZone, Process Intelligence, and GRC Lounge. It also includes a "We ♥ BPM" logo and a link to "ARIS COMMUNITY →".

Each community page shows a "NEWS" section with recent articles, such as "New TECHniques edition now available!" and "Software AG beats Oracle, Accenture and Wipro in BusinessWeek Hot Tech 50". There are also "DISCUSSION FORUMS" sections with various posts and "Enhancement Requests" sections.

# Discussion Forums : <http://tech.forums.softwareag.com/>

Ask a question and find an answer from an expert. Find out what users discussed most

- 100+ discussion forums
- List of most discussed & popular topics as well as top contributors
- RSS updates & email notifications
- Sharing content



The image displays three overlapping screenshots of the software AG Communities forum interface. The top screenshot shows the 'Discussion Forums Overview' page, which includes a navigation menu on the left and a main content area with a search bar and login options. The middle screenshot shows the 'NaturalONE Community Forums' page, featuring a table of forum topics and a list of top contributors. The bottom screenshot shows a specific discussion thread titled 'NaturalONE vs Natural for Windows', with a poll asking if users need a separate license for Natural for Windows CE. The thread includes user avatars, post dates, and content.



# User Generated Content & Help for Natural Developers

## Community wiki:

Find out the benefits of upgrading to different versions of Adabas and Natural and even more interesting articles in the community wiki

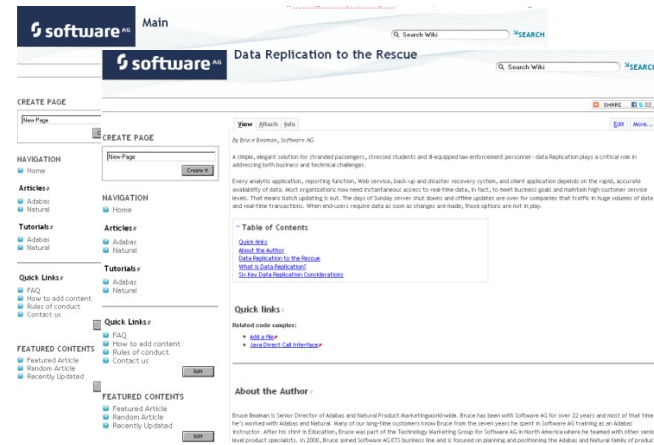

## New Natural code sample section

Code samples integrated with NaturalONE development environment

- submit code samples yourself
- easily search the code samples library

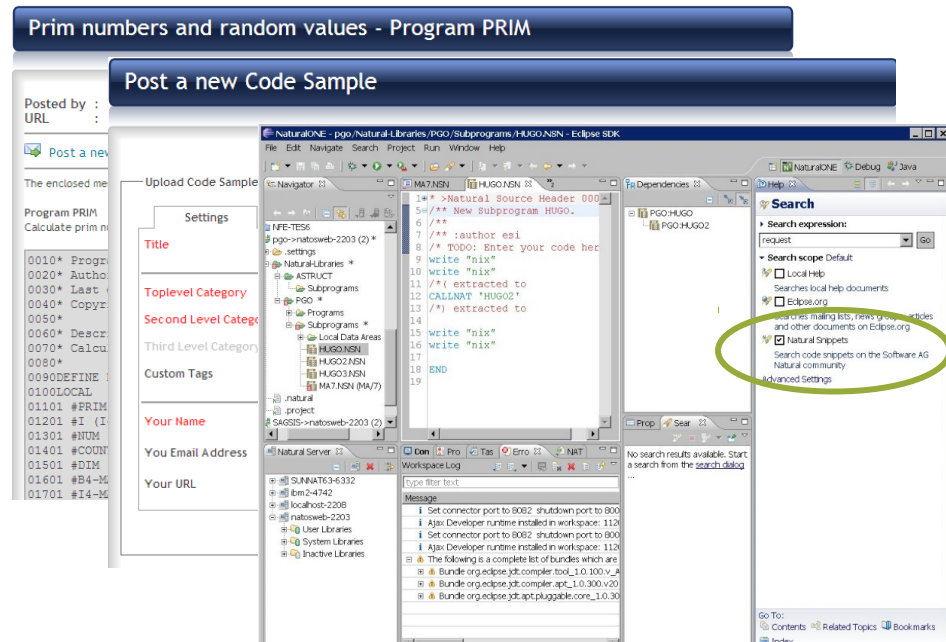

## Today's Agenda

- An own Theme Engine to automatically adapt page structures and layouts (components, color coding, etc ...)
- Enhanced error handling, to better react to problems on the page or parts of the page, using e-mail notification
- Code Samples with IDE integration
- Community Event Management with MS Exchange integration
- Integration with a Single Sign On (SSO) system
- OpenBlog - A Blog module for OpenCms
- Useful backend extensions

## Module 3

# An own theme engine to automatically adapt page structures and layouts

## Why a Theme Engine

- Share documents across different sub sites with different layouts.
  - Content is maintained only once, even if the page exists with different layouts.
  - Different themes can be applied to different „siblings“ of the same object.
- Save time, when you have layout changes (simply create a new theme)
- Single objects are not physically involved.
  - Themes are linked to folders by default.
  - Themes linked to a folder apply to all elements in that folder as well as to all subfolders and all elements in subfolders.
  - Themes can be assigned to single files on an individual base.
- Zero Maintenance
  - No need to assign a theme to an object at creation time.
  - No need to do any changes, when changing the layout of a page. Theme changes automatically when objects are moved to other folders.

# Theme Engine - Big Picture

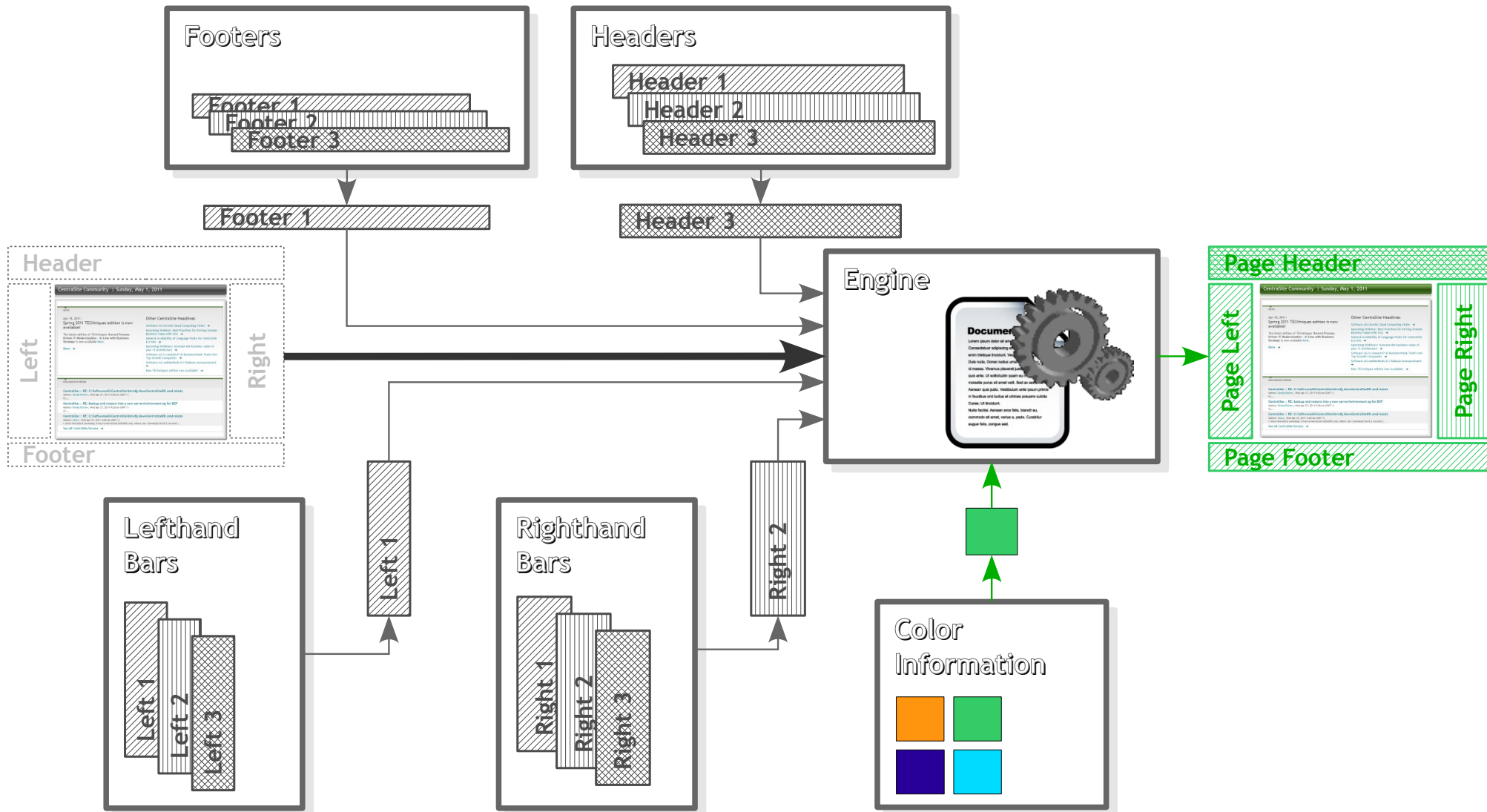

# Theme Engine - Sample 1

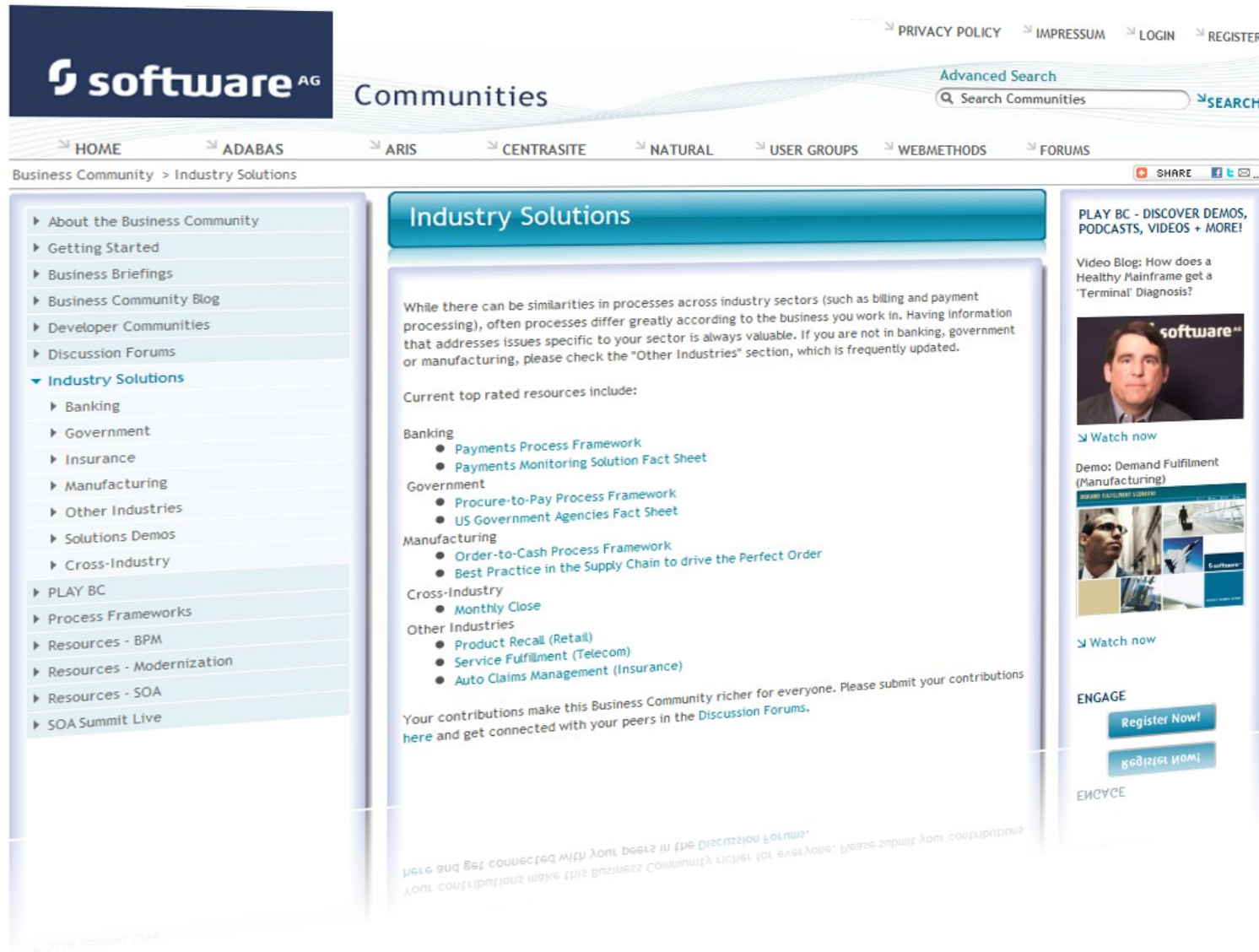

The screenshot displays the 'software AG Communities' website. The top navigation bar includes links for PRIVACY POLICY, IMPRESSUM, LOGIN, and REGISTER. Below this is a search bar with the text 'Advanced Search' and 'Search Communities'. A secondary navigation bar lists categories: HOME, ADABAS, ARIS, CENTRASITE, NATURAL, USER GROUPS, WEBMETHODS, and FORUMS. The main content area is titled 'Business Community > Industry Solutions' and features a sidebar with a tree view of navigation options. The central 'Industry Solutions' section contains introductory text, a list of current top-rated resources categorized by industry (Banking, Government, Manufacturing, Cross-Industry, and Other Industries), and a call to action for user contributions. The right sidebar includes a video blog section with a 'Watch now' button and an 'ENGAGE' section with a 'Register Now!' button.

**software** AG

PRIVACY POLICY | IMPRESSUM | LOGIN | REGISTER

Advanced Search  
Search Communities | SEARCH

HOME | ADABAS | ARIS | CENTRASITE | NATURAL | USER GROUPS | WEBMETHODS | FORUMS

Business Community > Industry Solutions

SHARE | Facebook | Twitter | Email

**Industry Solutions**

While there can be similarities in processes across industry sectors (such as billing and payment processing), often processes differ greatly according to the business you work in. Having information that addresses issues specific to your sector is always valuable. If you are not in banking, government or manufacturing, please check the "Other Industries" section, which is frequently updated.

Current top rated resources include:

- Banking**
  - Payments Process Framework
  - Payments Monitoring Solution Fact Sheet
- Government**
  - Procure-to-Pay Process Framework
  - US Government Agencies Fact Sheet
- Manufacturing**
  - Order-to-Cash Process Framework
  - Best Practice in the Supply Chain to drive the Perfect Order
- Cross-Industry**
  - Monthly Close
- Other Industries**
  - Product Recall (Retail)
  - Service Fulfillment (Telecom)
  - Auto Claims Management (Insurance)

Your contributions make this Business Community richer for everyone. Please submit your contributions here and get connected with your peers in the Discussion Forums.

PLAY BC - DISCOVER DEMOS, PODCASTS, VIDEOS + MORE!

Video Blog: How does a Healthy Mainframe get a 'Terminal' Diagnosis?

software AG

Watch now

Demo: Demand Fulfillment (Manufacturing)

Watch now

ENGAGE

Register Now!

Register Now!

ENCYCE

Your contributions make this Business Community richer for everyone. Please submit your contributions here and get connected with your peers in the Discussion Forums.

# Theme Engine - Sample 2

The screenshot displays the 'software AG Communities' website. At the top, there is a navigation bar with links for 'PRIVACY POLICY', 'IMPRESSUM', 'LOGIN', and 'REGISTER'. Below this is a search bar labeled 'Advanced Search' with the text 'Search Communities' and a 'SEARCH' button. A secondary navigation bar includes 'HOME', 'ADABAS', 'ARISALIGN', 'CENTRASITE', 'NATURAL', 'USER GROUPS', 'WEBMETHODS', and 'FORUMS'. Social media sharing icons for 'SHARE', 'f', 't', and 'e' are also present.

The main content area features a green header for 'Industry Solutions'. Below it, a text block explains that while processes are similar across sectors, they often differ. It lists 'Current top rated resources include:' followed by categories: Banking (Payments Process Framework, Payments Monitoring Solution Fact Sheet), Government (Procure-to-Pay Process Framework, US Government Agencies Fact Sheet), Manufacturing (Order-to-Cash Process Framework, Best Practice in the Supply Chain to drive the Perfect Order), Cross-Industry (Monthly Close), and Other Industries (Product Recall (Retail), Service Fulfillment (Telecom), Auto Claims Management (Insurance)). A call to action encourages contributions to the Discussion Forums.

On the right side, there is a 'CENTRASITE PRODUCTS' section with a list of products: Active SOA, Community Edition, Enterprise Edition, Governance Edition, and Mediator. Below the list are icons for 'Articles', 'Documentation', 'Downloads', 'Events Archive', 'Integration Tools & Demos', 'Newsletters', 'Tips & Tricks', and 'Tutorials'.

At the bottom, a horizontal navigation bar contains icons and labels for 'Enhancement Requests (Brainstorm)', 'Universities', 'Events', 'SOA Value Assessment', 'Training & Courses', and 'Contact Us'. A second, slightly faded version of this bar is visible below it.

# Module 4

## Enhanced error handling



## Enhanced Error Handling

- Avoid time consuming search for the log entries of interest for you and be notified automatically.
- Define different notifications for different folders.
  - Customize the error message shown to users for any folder you like.
  - Use Regular Expressions for customization.
  - Define as many recipients as you like for notification mails.
- Be notified immediately and not at the moment, when you analyze the log file. This may be too late.
- Be also notified on mail capable mobile devices like Blackberrys and other Smartphones.
- Automatically attach log file to notification mails (planned).

# Enhanced Error Handling - Big Picture

The image shows a screenshot of a web browser window and a configuration tool. The browser window displays a server error message: "We are sorry, but the page you were looking for reported a server error. Please visit <http://communities.softwareag.com> and choose your preferred Community site. If you have any questions, please email: [technologycommunity@softwareag.com](mailto:technologycommunity@softwareag.com)". The browser's address bar shows the URL `http://communities.softwareag.com/ecosystem/communities/public/universities/`, with the path `/public/universities/` circled in red.

The configuration tool shows a list of folders on the right, including `protected`, `developer`, `ideas`, `universities`, `public-old`, and `public`. The `universities` folder is circled in red. A red arrow points from the circled `universities` folder in the browser's address bar to the circled `universities` folder in the configuration tool's folder list.

The configuration tool also shows a "Handler Mapping [1]" section with the following details:

- Generate Mail:
- Mail Recipient: [redacted]
- URL Pattern: `^/public/universities/(.*)$` (circled in red)
- Text: "We are sorry, but the page you were looking for reported a server error. Please visit <http://communities.softwareag.com> and choose your preferred Community site. If you have any questions, please email: [technologycommunity@softwareag.com](mailto:technologycommunity@softwareag.com). We will be pleased to help you."

At the bottom of the configuration tool, another handler mapping is visible with the URL Pattern `^/protected/universities/(.*)$` (circled in red).

# Enhanced Error Handling - Sample Output

The image displays three overlapping screenshots illustrating error handling:

- Top Left:** Website header for 'software AG' with navigation links: HOME, ADABAS, ARISALIGN, CEN.
- Top Right:** An email inbox window showing an error report from 'communities@softwareag.com' with the subject 'Error Report from "communities.softwareag.com"'. Other emails from HubSpot and Dedov, Bozhidar are also visible.
- Bottom:** A detailed error page with a red 'X' icon. The text reads:
 

**An error occurred while processing the resource**  
**Server Error 500**  
**Internal Server Error**

The call of the URL `"/ecosystem/communities/public/index.html"` produced the following error :  
**java.lang.ArithmeticException: / by zero**

No stacktrace available !

We are sorry, but the page you were looking for reported a server error.  
 Please visit <http://communities.softwareag.com> and choose your preferred Community site.  
 If you have any questions, please email: [technologycommunity@softwareag.com](mailto:technologycommunity@softwareag.com)

We will be pleased to help you.

# Module 5

## Code Samples with IDE integration

## What are Code Samples ?

- Code snippets available for common use on the Internet
  - Registered community users can contribute their own code snippets.
  - Registered community users can modify code snippets.
  - Everyone can view and download code snippets.
- Directly usable in own applications.
- Code snippets are available as HTML pages.
- Code within the snippets can be downloaded separately and used directly.
- Separate detailed description available for each code snippet.

# What are Code Samples ?

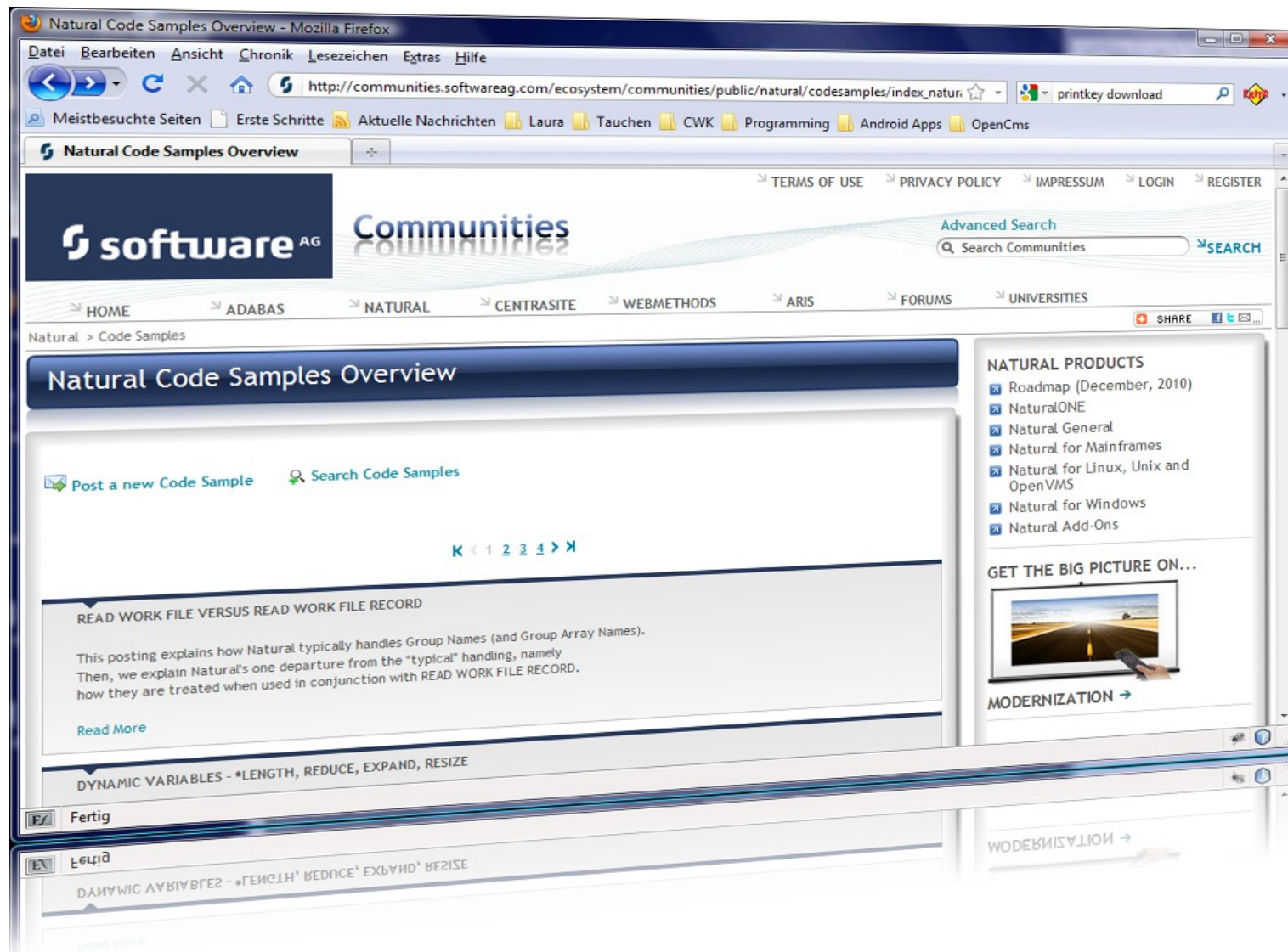

# What are Code Samples ?

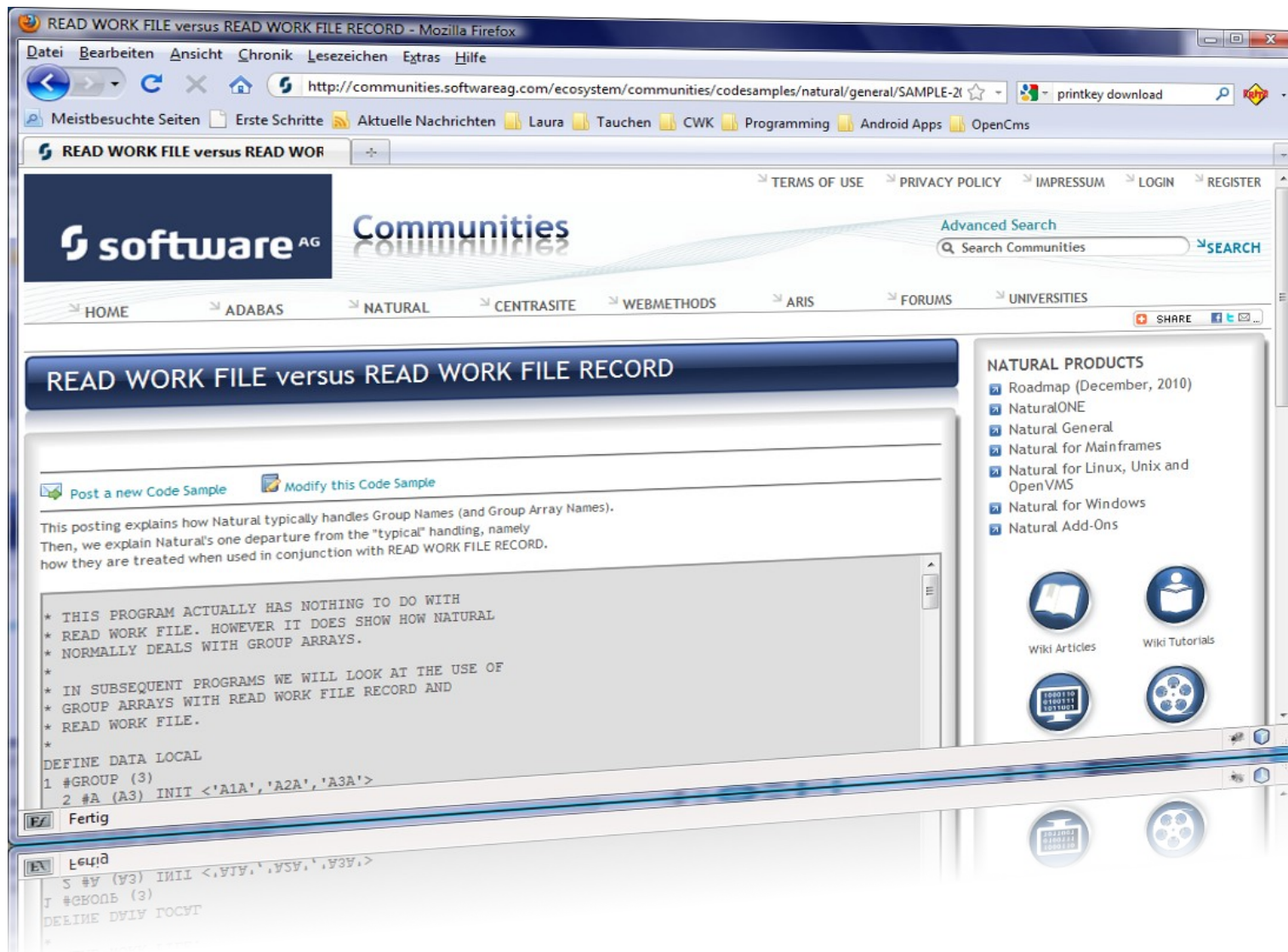

# What are Code Samples ?

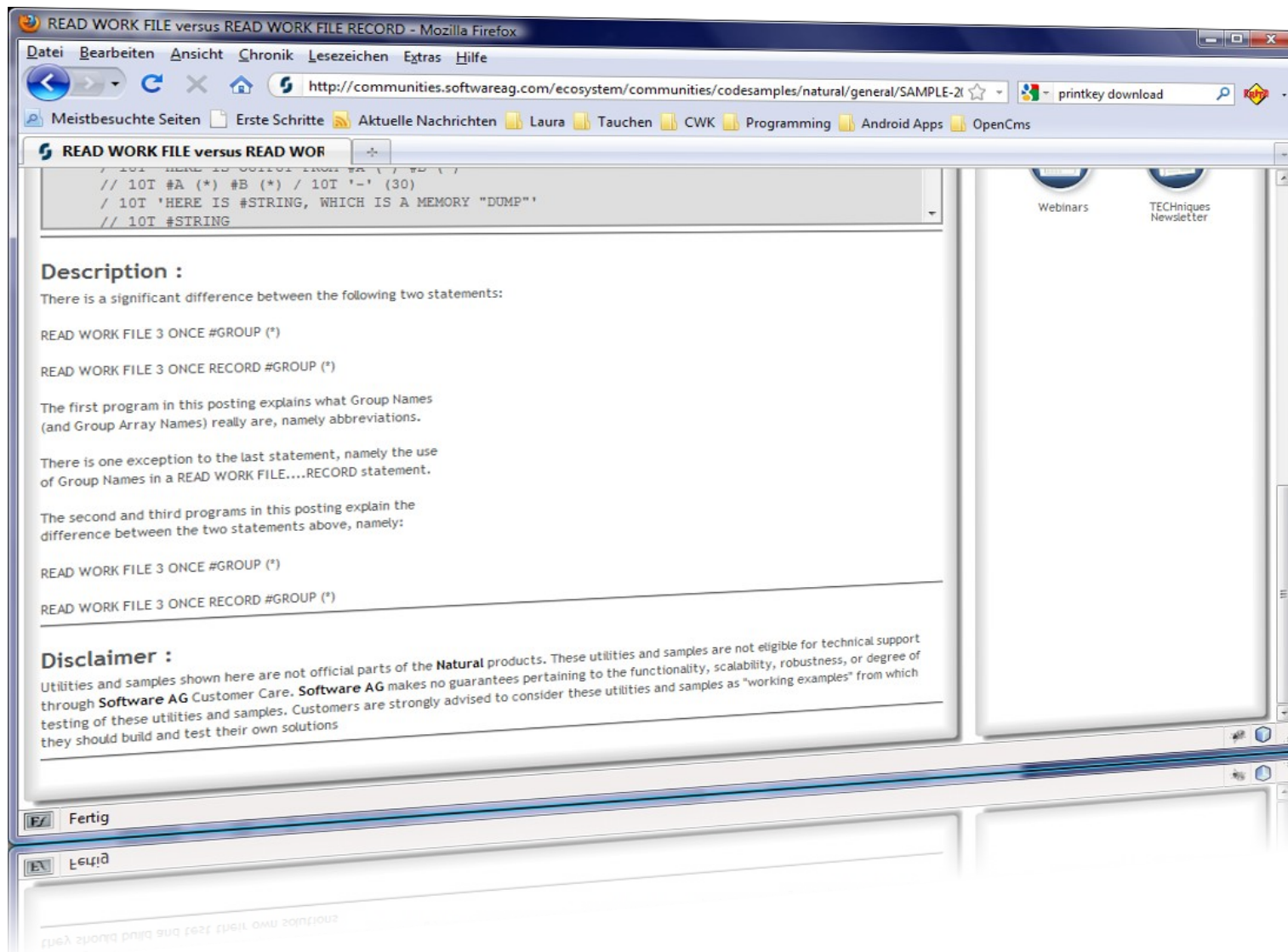



# Search Interface

```

- <sag:search-results pagecount="10" page="5" index-id="adabas" index="Ecosystem Adabas Community" query="Natural" results="5">
- <sag:item index="25">
- <sag:title>
  Improving System Performance at Newell Rubbermaid with Adabas Fastpath
</sag:title>
<sag:score>19%</sag:score>
<sag:keywords/>
- <sag:link>
  /ecosystem/communities/public/Developer/adabas/products/adabas/articles/Adabas_Fastpath.html
</sag:link>
- <sag:excerpt>
  By Bruce Beaman, Senior Director of Adabas & Natural Product Marketing Are you feeling CPU-constrained? Concerned about a costly machine upgrade? Are you meeting your SLAs to end users? Read this article to learn how Newell Rubbermaid ensured sub-second performance for 23,500 employees accessing Adabas data through online applications, even with 99% of these employees working in remote locations and batch jobs running against the same databases around the clock. Additionally, Newell ...
</sag:excerpt>
<sag:description/>
<sag:last-modified>Mon Mar 01 13:12:36 CET 2010</sag:last-modified>
</sag:item>
- <sag:item index="26">
- <sag:title>
  How the ADABAS SOA Gateway Will Help You Support a Service-oriented Architecture
</sag:title>
<sag:score>19%</sag:score>
<sag:keywords/>
- <sag:link>
  /ecosystem/communities/public/Developer/adabas/products/adabas/articles/Adabas_SOA_Gateway.html
</sag:link>
  
```

## Software AG Communities Search

---

### SOFTWARE AG COMMUNITIES SEARCH

**Search results for query "Natural" by community :**

▼ **Adabas Community (48)**

[K](#)
[<](#)
[1](#)
[2](#)
[3](#)
[4](#)
[5](#)
[6](#)
[7](#)
[8](#)
[9](#)
[10](#)
[>](#)
[X](#)

**26 - Improving System Performance at Newell Rubbermaid with Adabas Fastpath (19%)**

By Bruce Beaman, Senior Director of Adabas & Natural Product Marketing Are you feeling CPU-constrained? Concerned about a costly machine upgrade? Are you meeting your SLAs to end users? Read this article to learn how Newell Rubbermaid ensured sub-second performance for 23,500 employees accessing Adabas data through online applications, even with 99% of these employees working in remote locations and batch jobs running against the same databases around the clock. Additionally, Newell ...

*Last Modified : Mon Mar 01 13:12:36 CET 2010*

**27 - How the ADABAS SOA Gateway Will Help You Support a Service-oriented Architecture**

By Bruce Beaman, Director Adabas & Natural Product Marketing For many organizations day to day challenges need to be addressed more immediately with tactical solutions. This requires you to act tactically while thinking strategically. Read this article How the ADABAS SOA Gateway Architecture ...

# Code Snippets from Developer Community

- Enter source code snippets in the Developer Community
- Source code can now be directly used by every NaturalONE developer

The screenshot shows the 'software AG Communities' website interface. At the top, there are navigation links for 'TERMS OF USE', 'PRIVACY POLICY', 'IMPRESSUM', 'PROFILE', and 'LOGOUT'. Below this is a search bar with the text 'Advanced Search' and 'Search Communities'. A secondary navigation bar includes links for 'HOME', 'ADABAS', 'ARISALIGN', 'CENTRASITE', 'NATURAL', 'USER GROUPS', 'WEBMETHODS', and 'FORUMS'. The main content area is titled 'Modify Code Sample' and features a tabbed interface with 'Code' selected. The code editor contains the following NaturalONE source code:

```
* THIS PROGRAM ACTUALLY HAS NOTHING TO DO WITH
* READ WORK FILE. HOWEVER IT DOES SHOW HOW NATURAL
* NORMALLY DEALS WITH GROUP ARRAYS.
*
* IN SUBSEQUENT PROGRAMS WE WILL LOOK AT THE USE OF
* GROUP ARRAYS WITH READ WORK FILE RECORD AND
* READ WORK FILE.
*
DEFINE DATA LOCAL
1 #GROUP (3)
2 #A (A3) INIT <'A1A','A2A','A3A'>
2 #B (A3) INIT <'B1B','B2B','B3B'>
1 REDEFINE #GROUP
2 #STRING (A18)
END-DEFINE
*
INCLUDE AATILER
INCLUDE AASEIC
*
WRITE 2/10 'HERE IS OUTPUT FROM #GROUP (*)'
// 10T #GROUP (*) / 10T '-'(30)
```

Buttons for 'Cancel' and 'Submit' are visible at the bottom right of the code editor.

# Code Snippets from Developer Community

- Search criteria requested via help key
- Search for source code snippets in the community
- Different search options
  - Title
  - Footer
  - Content
  - Description

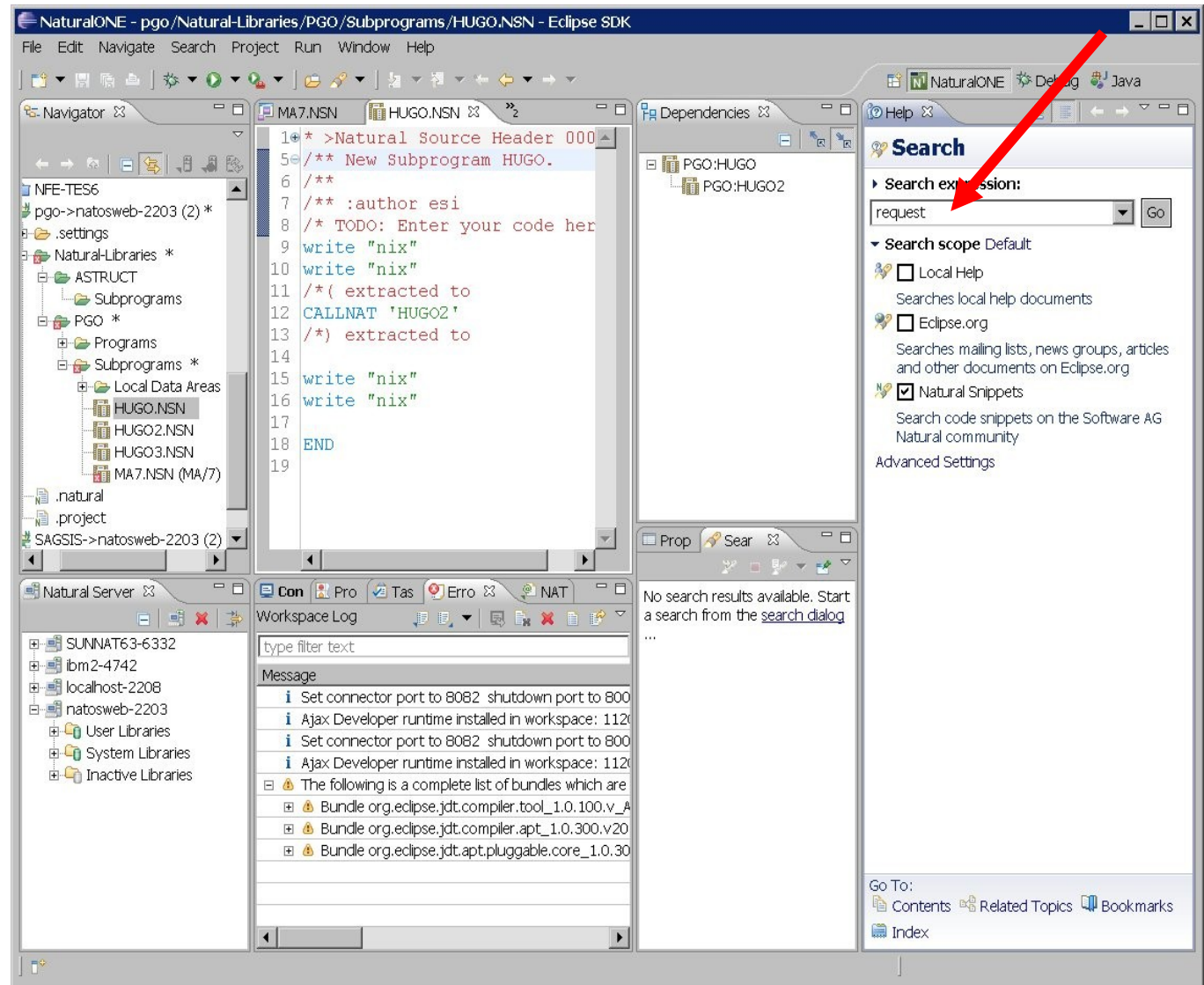

# Code Snippets from Developer Community

- Results shown in search view
- Select one hit for details

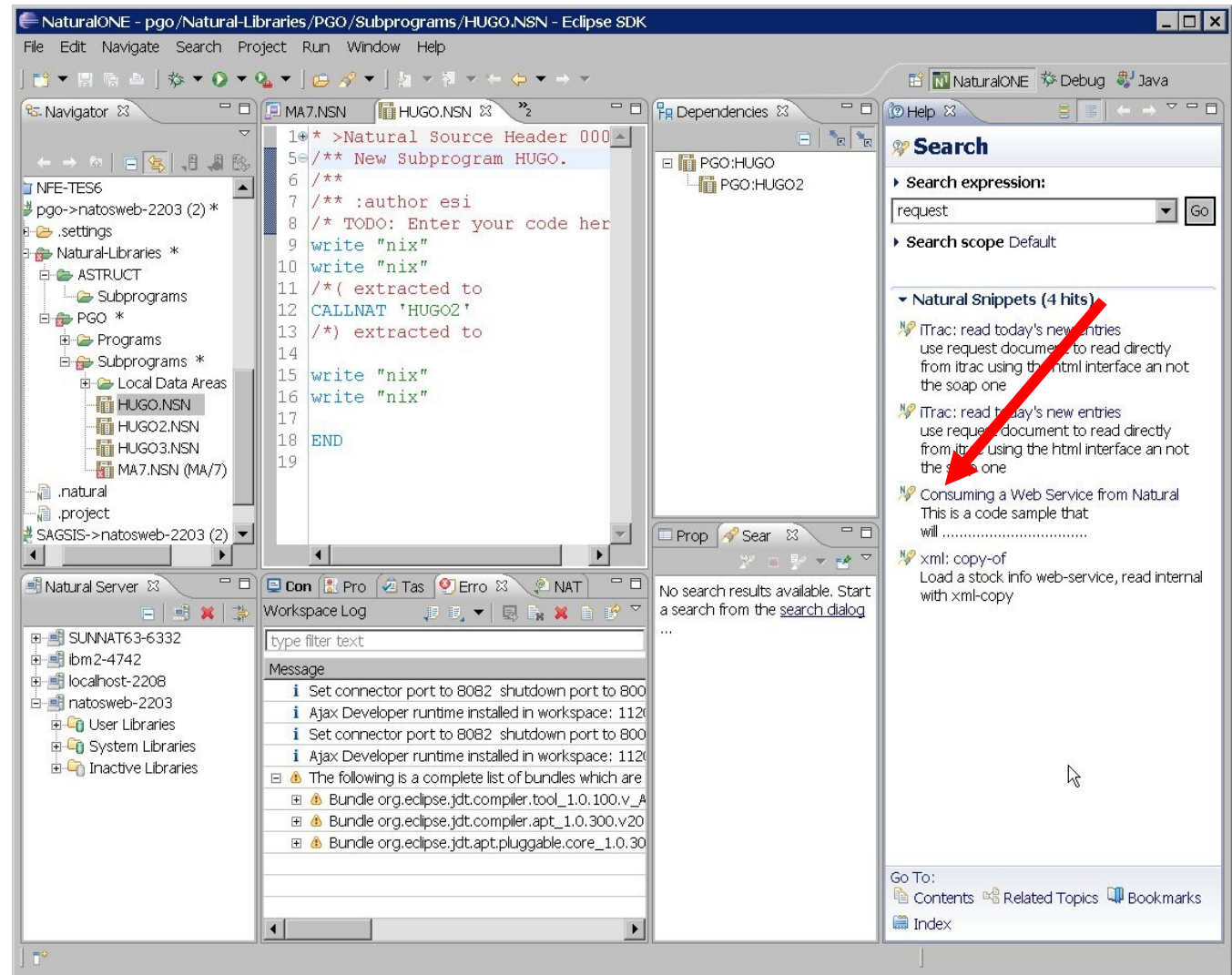

# Code Snippets from Developer Community

- Source Code snippet shown in search view

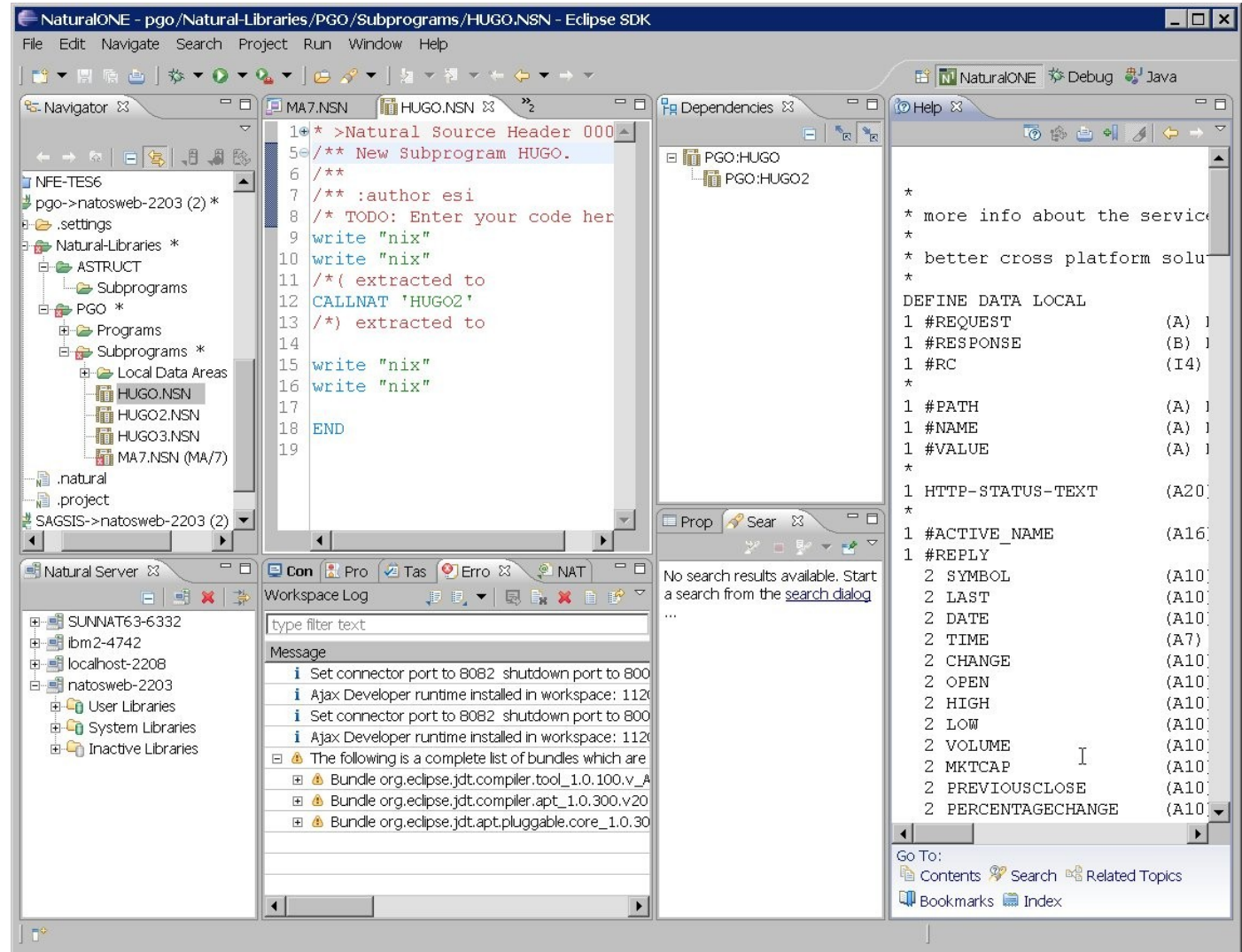

# Code Snippets from Developer Community

- Select source code to be copied
- Copy Source Code to NaturalONE editor

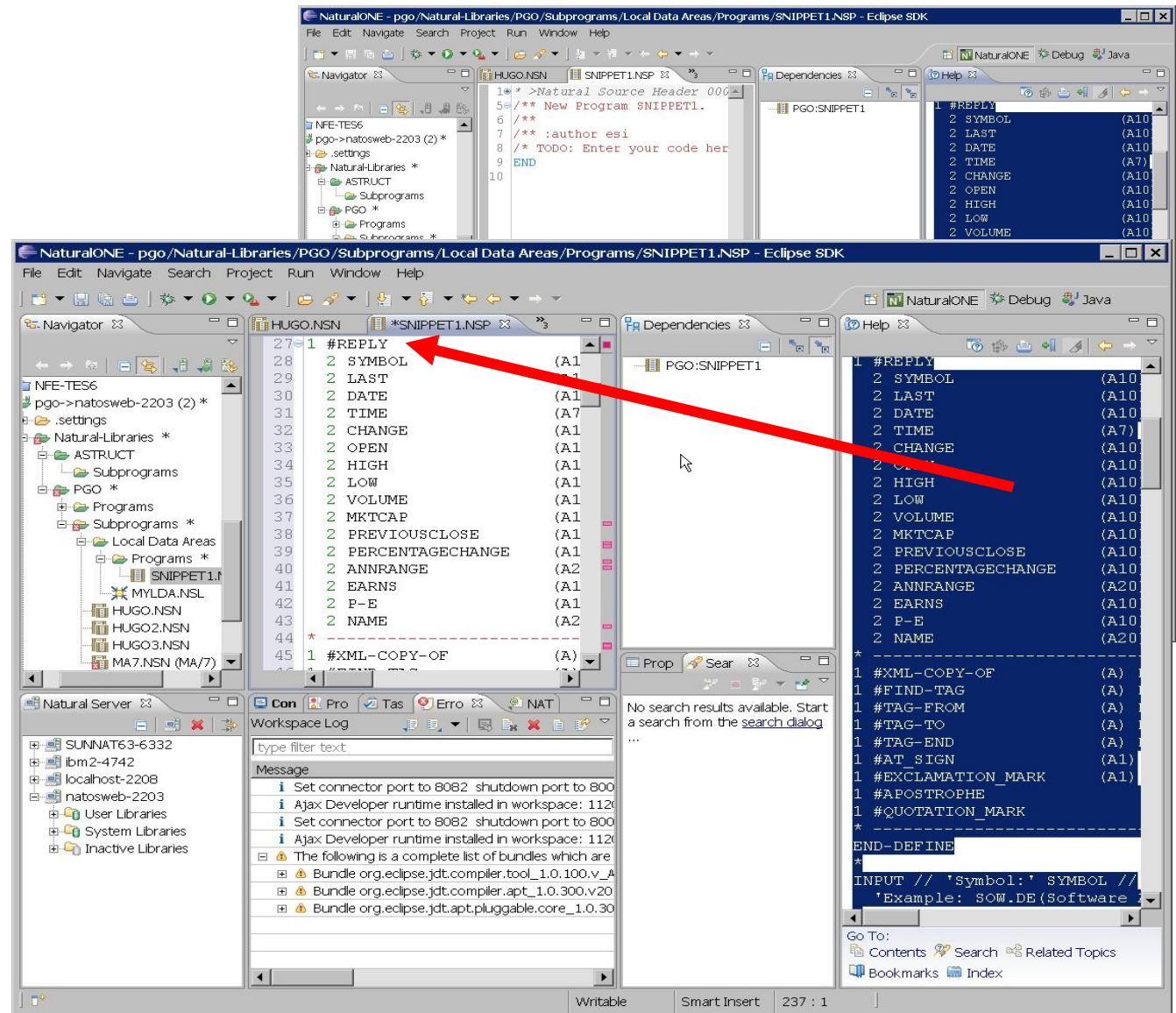

# Module 6

## Community Event Management

## Community Event Management with MS Exchange integration

- Requirements:
  - individual and geographically distributed Software AG stakeholders need to manage community events
  - arbitrary event types (e.g fair, congress, product release)
  - arbitrary calendars for individual community interest groups
  - system's physical network location (DMZ) requires OpenCms to provide storage, editing and rendering capabilities for events



# Community Event Management with MS Exchange integration

- Solution:



## OpenCms Calendar module

# Community Event Management with MS Exchange integration

- Features:
  - colour schemes for arbitrary event types
  - visible timespan configurable (e.g. only 6 months)
  - automatic RSS-Feed aggregation
  - calendars can have POP3/IMAP accounts assigned for automatic event creation via e-mail invitation
  - easy calendar maintenance for CMS authors as standard OpenCms mechanisms apply (events are structured content items/documents)

# Community Event Management with MS Exchange integration

- Monthly View

The screenshot shows a calendar application with a monthly view for 2011. The header includes the 'software AG' logo and the text 'Dummy Events for OpenCms Days 2011'. The calendar grid shows months from Jan to Jul. A popup window for 'OpenCms Days 2011' is open, displaying the event details:

Month	Day	Event
Mar, 2011	01	CEBIT
May, 2011	09	OpenCms Days 2011
May, 2011	10	OpenCms Days 2011
May, 2011	27	OpenCms Days 2011

**OpenCms Days 2011**  
**DAYS 2011**  
 From : Mon, May 09, 2011  
 To : Tue, May 10, 2011  
 Hosted by : OpenCms Days 2011  
 Software AG contact : [Robert Diawara](#)  
 OpenCms Days 2011 - Hier wird die neue Version 8 von OpenCms vorgestellt und deren neuen Funktionen in Workshops von Experten der Alkacoon Software erklärt.  
 For more details, click [here](#).

# Community Event Management with MS Exchange integration

- Detail View

The screenshot shows a calendar interface with a detailed view of an event. The event is titled "OpenCms Days 2011" and features the "OpenCms DAYS 2011" logo. The event details are as follows:

- From:** Mon, May 09, 2011
- To:** Tue, May 10, 2011
- Hosted by:** [OpenCms Days 2011](#)
- Software AG contact:** [Robert Diawara](#)

The event description reads: "OpenCms Days 2011 - Hier wird die neue Version 8 von OpenCms vorgestellt und deren neuen Funktionen in Workshops von Experten der Alkacon Software erklärt." Below the description, there is a link: "For more details, click [here](#)."

# Module 7

## Integration with a Single Sign On (SSO) system

# Sign On Process Implementation Sample

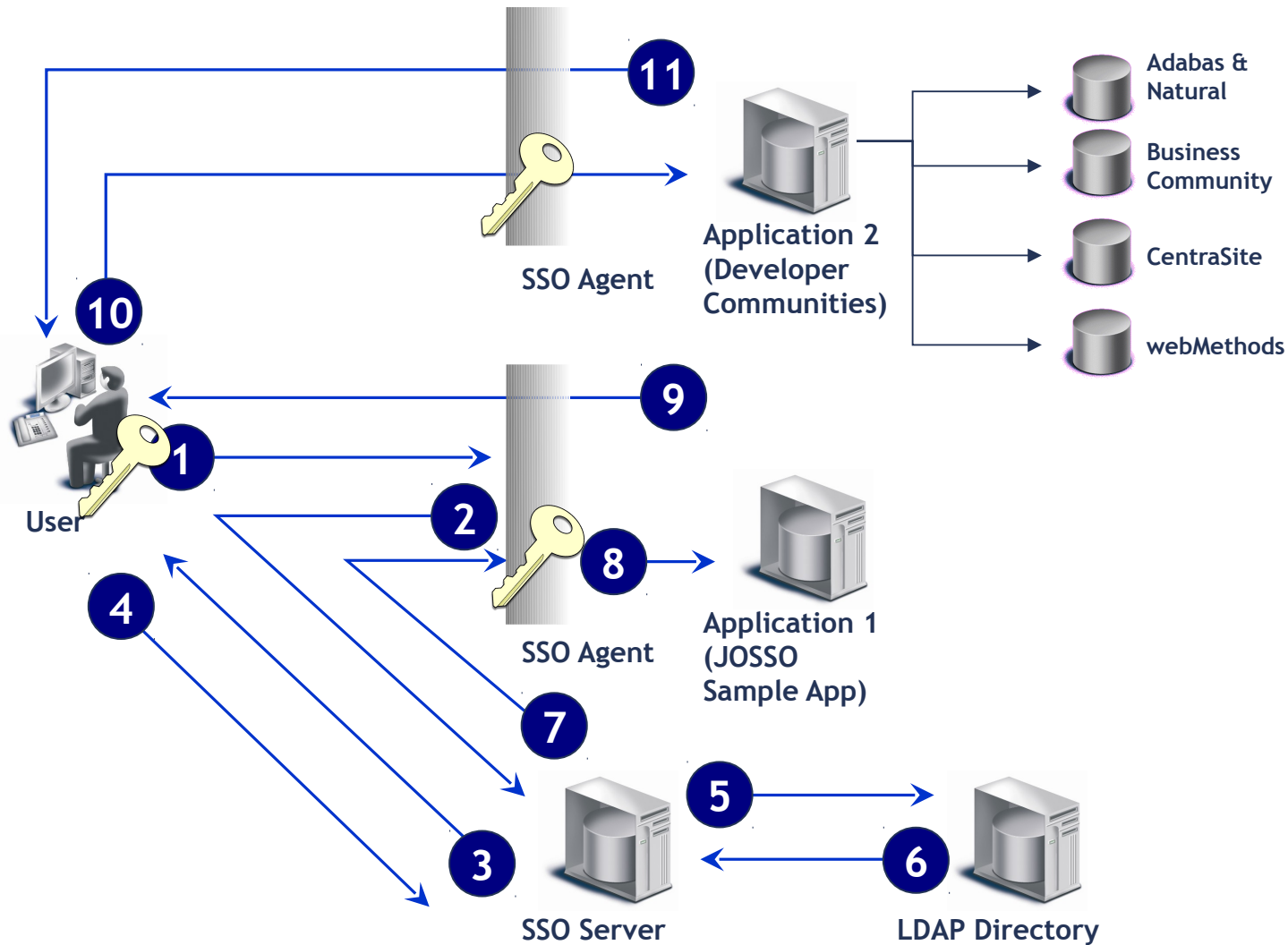

1. Request protected resource from Application 1
2. Redirect to sign on server
3. Request credentials
4. Provide credentials
5. Check credentials
6. Approve sign on
7. Redirect back to application and provide token to the user
8. Perform request
9. Display resource to user
10. Request protected resource from Application 2
11. Display resource to the user

## How to integrate JOSSO with OpenCms?

- componio's “SimSim” SSO module for OpenCms:
  - supports multiple approaches
    - ▶ JOSSO
    - ▶ NTLM
    - ▶ CAS
    - ▶ COOKIE
  - transparently embedded → no end user action required
  - OpenCms' user right management still applies
  - requires a directory connector (e.g. Alkacon OCEE)

# Sample SSO OpenCms Access (simplified view)

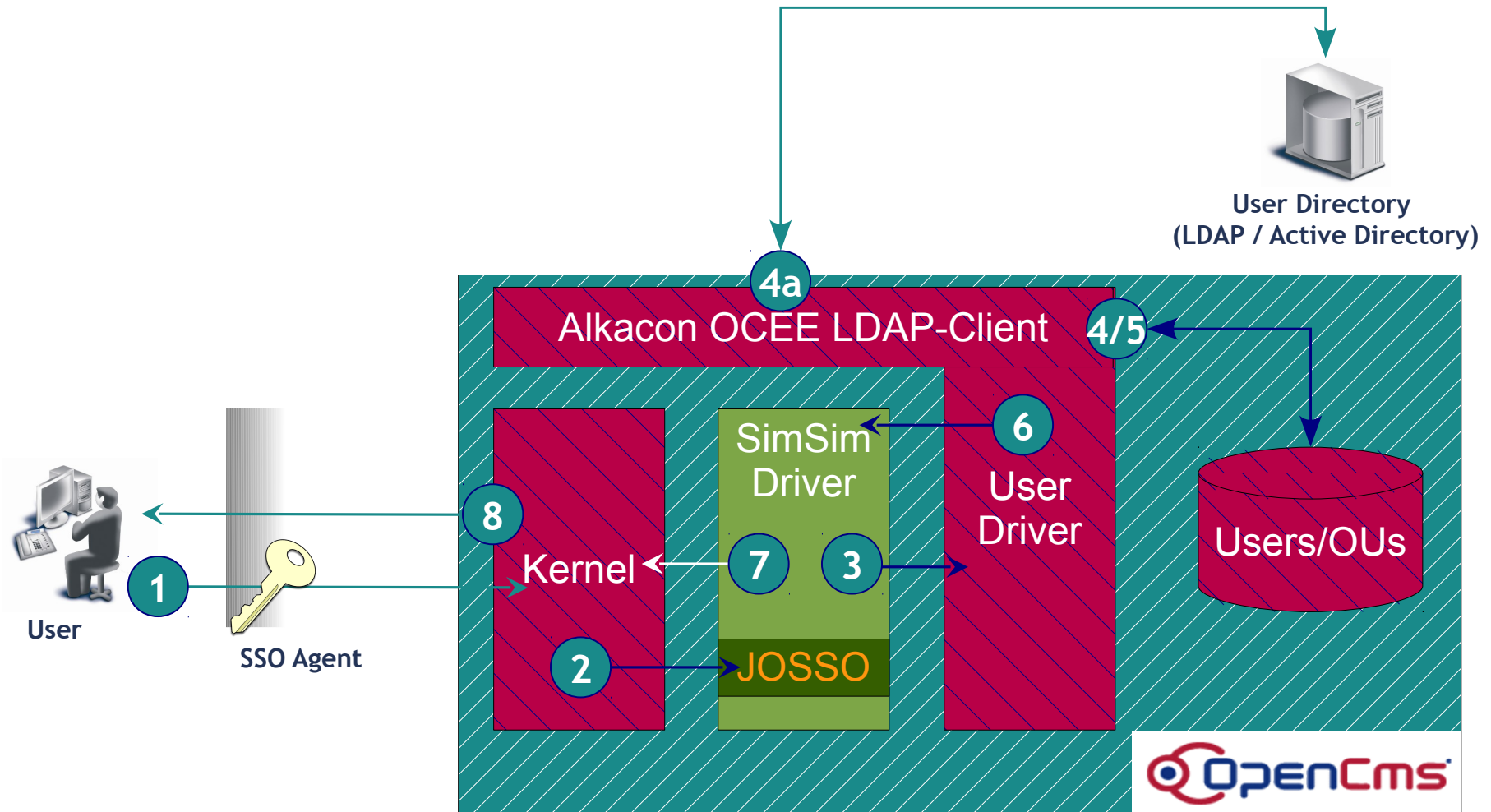



# Module 8

## OpenBlog - A Blog module for OpenCms

**OpenBlog**

OpenBlog

!=

i=



# OpenBlog with OpenCms - Motivation



- OpenCms is
  - reliable
  - proven to work
  - easy to use
  - multi-user and
  - multi-language enabled
  - many features out of the box
- no additional software installation
- content authors were already acquainted with OpenCms and its capabilities
- very easy to extend

# OpenBlog - Features

- arbitrary Blogs within one site
- Blog administration via OpenCms' Administration section
- offers basic Blog features such as
  - chronological blog entries
  - commenting
  - content taxonomies (e.g. tagging)
  - content syndication (e.g. RSS feeds)
  - notifications
  - basic SPAM prevention
- fully integrated with OpenCms' content paradigms (e.g user rights, publishing, content editing)

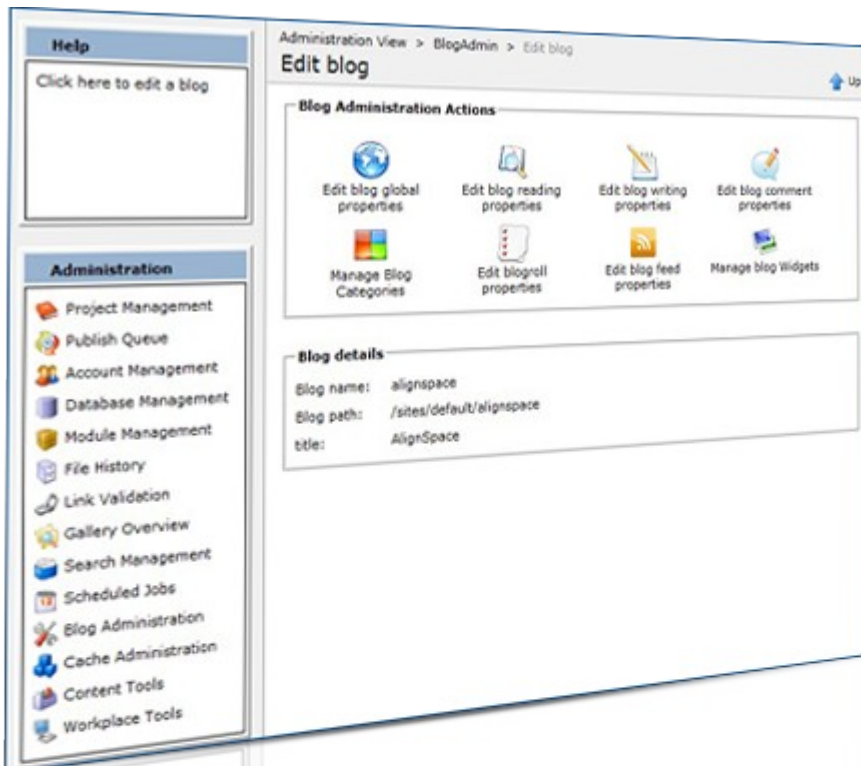

# OpenBlog - Widgets

- lightweight encapsulated containers
- individually configurable
- plug-in concept to enable third-party extensions
- 15+ currently available such as
  - Blogroll
  - Latest Articles
  - Latest Comments
  - Article Archive
  - Twitter/Facebook feed
  - Most Popular Articles
  - Best Rated Articles
  - Most Commented Articles
  - ...

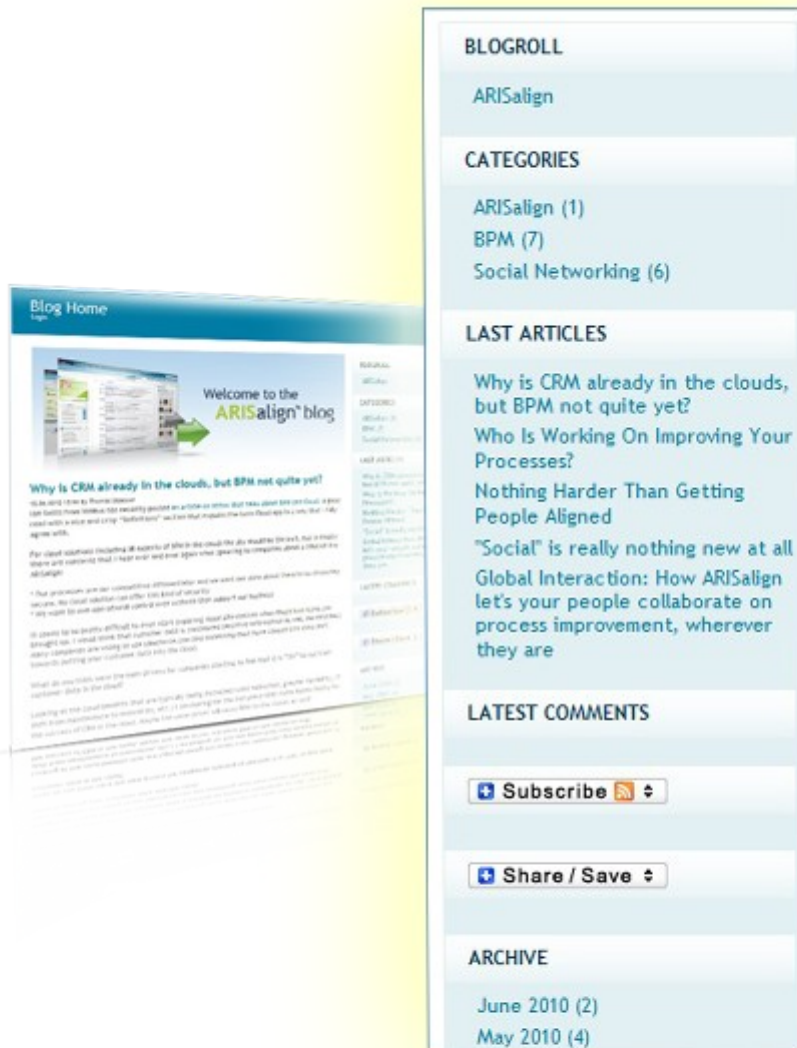

# OpenBlog - Article Editing

Language English

Title: Q&A from Launch Webinar

Date: 3/30/2010 1:10 PM

Author: Thomas Stoesser (tsto)

Category: (Click on the "New" button on the right side to activate this element)

Teaser: (Click on the "New" button on the right side to activate this element)

Content:

We had lots of questions during and after the ARISalign launch webinar and there was simply not enough time to answer them all during the call. As promised, here are all the questions that were asked and the answers to them. [You can also find the Q&A in the ARISalign group on ARISalign](#). Feel free to post your comments in that group or to start a discussion around a question that you would like to get answered.

**Q: What is the roadmap for ARISalign beyond the beta phase?**  
**A:** From an integration point of view I think this can be best visualized by showing the same slide that we presented during the press conferences at Cebit:



TaPublishDirectly: (Click on the "New" button on the right side to activate this element)

Publishing Time : 3/30/2010 1:10 PM

Publish Method: publishing comments automatically

ForbidComments:

DisallowPingback:

DisallowTrackback:

TrackbackLink:

- structured content template
- one document per article
- standard OpenCms widgets and editors
- customizable behaviour overwrites general settings
  - publishing
  - commenting
  - ping/trackback

# Comment Editing

The screenshot displays a web-based comment editing interface. At the top, there is a language selector set to 'English'. The interface is divided into two main sections, each representing a comment entry.

**Comment [1]:**

- Activated:**
- Author:** Robert Diawara
- Date:** 03/09/2010 09:02 AM
- Email:** robert.diawara@componio.net
- Website:** (Click on the "New" button on the right side to activate this element)
- Content:** OpenBlog fits like a glove! Keep up the good work...
- IP:** [Empty field]
- Type:** [Empty field]

**Comment [2]:**

- Activated:**
- Author:** Fabian Huschka
- Date:** 03/12/2010 09:03 AM
- Email:** fabian.huschka@componio.net
- Website:** (Click on the "New" button on the right side to activate this element)
- Content:** I am glad to hear this. I will pass on kudos to the developers ..

Each comment entry includes a rich text editor toolbar with icons for undo, redo, bold, italic, underline, link, unlink, list, and other text formatting options.

- structured content template
- standard OpenCms widgets and editors
- each blog article has one document associated which stores the comments

# OpenBlog - Screenshot

## Blog Home

Login

- My First Experience with ARISalign      Q&A from Launch Webinar -

### The New BPM Guru: Why Experts Still Matter

As BPM modeling becomes more accessible to more people in an organization through integration with social networking & collaboration technology, BPM experts may wonder what their role will be. The advantage of the ARISalign interactive modeling workspace is that the information it gathers to build the model of an organization is much more granular and detailed.

But the number of individual contributors to an organization's process model will greatly expand, in some cases including management and front-line employees plus outside consultants.

...the more granular level of detail adds to the value of the information. They'll also...

**BLOGROLL**

ARISalign

**CATEGORIES**

ARISalign (1)  
BPM (7)  
Social Networking (6)

**LAST ARTICLES**

May 2009 (2)  
April 2009 (3)  
March 2009 (3)  
February 2009 (3)  
January 2009 (1)

**TOP RATED**

Powered by  
**software**

...any responses to this article...  
...back from your own site or [bookmark](#) it.

Rate this article

★★★★★ 0%



**Leave a Reply**

Name (required)

Mail (will not be published) (required)

Website

deraigned, dearyeah

stop spam.  
read books.

[Entries \(RSS\)](#) and [Comments \(RSS\)](#) | [Imprint](#)

http://www.arisalign.com



# Module 9

## Useful backend extensions

# Many more widgets and modules

- TagCloud
- Alfresco Integration
- 5 Star Rating
- Comments with E-Mail notifications
- Message Channels (Twitter style)
- Frontend Content Contribution (upload, taxonomies, automated content review)
- Frontend document editing with WYSIWYG-Editor
- ...

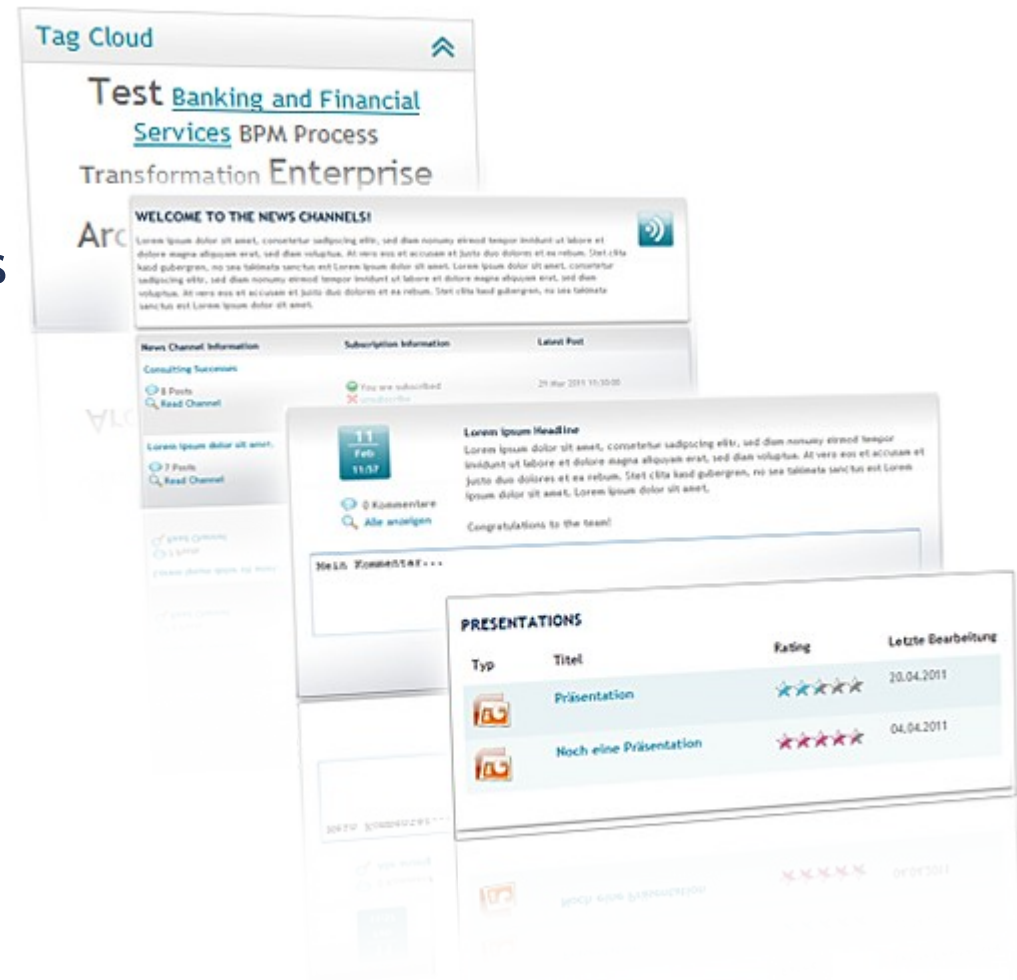

## FTP Folder - an example

- FTP Folder view as own resources
  - Storing pointer-resources instead of files in OpenCms VFS
  - Depth of folder-synchronization adjustable
  - Using as normal resources, such as physical files within OpenCms
  - Scheduled synchronization for ftp server and “FTP Folder”
  - Downloading:
    - (1) For an anonymous ftp server, direct download possible (link)  
ftp://anonymous@ftp.server.com/folder/file.pdf
    - (2) For private ftp server, it is possible to download the file without knowing username and password for authentication (file-proxy)  
ftp://username:password@ftp.server.com/folder/file.pdf

## FTP Folder - an example

- Creating a new resource (FTP Folder)
  - Defining informations as properties:
    - ▶ Server address
    - ▶ Username and password
    - ▶ Synchronization time
  - Creates automatically
    - ▶ external link structure
    - ▶ ScheduledJob

**Edit properties of: PublicFTPFolder/**

Property	Value	
Description	<input type="text"/>	<input type="checkbox"/>
FTP-Cronjob	0 30 4 * * ?	<input type="checkbox"/>
FTP-Hostname	ftp://ftp-sfb288.math.tu-berlin.de/pub/geomvie	<input checked="" type="checkbox"/>
FTP-Password	secret	<input checked="" type="checkbox"/>
FTP-Username	componio	<input checked="" type="checkbox"/>
Keywords	<input type="text"/>	<input type="checkbox"/>
NavImage	<input type="text"/>	<input type="checkbox"/>
NavInfo	<input type="text"/>	<input type="checkbox"/>
NavPos	<input type="text"/>	<input type="checkbox"/>
NavText	<input type="text"/>	<input type="checkbox"/>
Title	This is a FTP Folder with authentication	<input checked="" type="checkbox"/>
admintoolhandler-args	<input type="text"/>	<input type="checkbox"/>
admintoolhandler-class	<input type="text"/>	<input type="checkbox"/>
cache	<input type="text"/>	<input type="checkbox"/>
category	<input type="text"/>	<input type="checkbox"/>

# FTP Folder - an example

The screenshot shows the OpenCms Workplace interface. The browser address bar displays `http://localhost:8081/opencms/opencms/system/workplace/views/workplace.jsp`. The interface includes a navigation bar with buttons for Back, Upload, Search, New, and Level Up. The current location is `/PublicFTPFolder/`. A file list is displayed with columns for Name, Title, Type, Size, and Date last modified. The files listed are:

Name	Title	Type	Size	Date last modified
forms-2.0_.all.tar.gz	forms-2.0+.all.tar.gz	pointer	79	5/4/11 11:22 AM
geomview-1.5.0-next.tar	geomview-1.5.0-next.tar	pointer	81	5/4/11 11:22 AM
geomview-1.6.1-alpha.tar.gz	geomview-1.6.1-alpha.tar.gz	pointer	85	5/4/11 11:22 AM
geomview-1.6.1-hpux.tar.gz	geomview-1.6.1-hpux.tar.gz	pointer	84	5/4/11 11:22 AM
geomview-1.6.1-irix4.tar.gz	geomview-1.6.1-irix4.tar.gz	pointer	85	5/4/11 11:22 AM
geomview-1.6.1-linux.tar.gz	geomview-1.6.1-linux.tar.gz	pointer	85	5/4/11 11:22 AM
geomview-1.6.1-rs6000.tar.gz	geomview-1.6.1-rs6000.tar.gz	pointer	86	5/4/11 11:22 AM
geomview-1.6.1-sgi.tar.gz	geomview-1.6.1-sgi.tar.gz	pointer	83	5/4/11 11:22 AM
geomview-1.6.1-solaris.tar.gz	geomview-1.6.1-solaris.tar.gz	pointer	87	5/4/11 11:22 AM
geomview-1.6.1-sun4.tar.gz	geomview-1.6.1-sun4.tar.gz	pointer	84	5/4/11 11:22 AM
geomview-1.6.1p9-src.tar.gz	geomview-1.6.1p9-src.tar.gz	pointer	85	5/4/11 11:22 AM
geomview-1.7-linux.tar.gz	geomview-1.7-linux.tar.gz	pointer	83	5/4/11 11:22 AM
geomview-1.7-src.tar.gz	geomview-1.7-src.tar.gz	pointer	81	5/4/11 11:22 AM
geomview-speedtests.tar.gz	geomview-speedtests.tar.gz	pointer	84	5/4/11 11:22 AM
manual.tar.gz	manual.tar.gz	pointer	71	5/4/11 11:22 AM
README.html	README.html	pointer	69	5/4/11 11:22 AM

At the bottom of the window, a status bar indicates: `User (Admin) logged in at 5/4/11 11:19 AM from 0:0:0:0:0:0:1%0`. The name `Fertig` is visible in the bottom left corner.

# Let's talk...



**Software AG**  
Uhlandstraße 12  
64297 Darmstadt  
Germany

**Robert Diawara**  
Diplom-Informatiker (FH)  
Manager Developer Communities

Phone +49(0)6151 92-3086  
robert.diawara@softwareag.com

**Fabian Huschka**  
Chief Information Officer  
+49 6151 500 367 0  
fabian.huschka@componio.net

[www.componio.net](http://www.componio.net)  
componio GmbH  
Robert-Bosch-Str. 7  
64293 Darmstadt



... and thank you for your attention!